

Wall Mount Installation Guide For 65" & 75", 85" & 86" & 98"

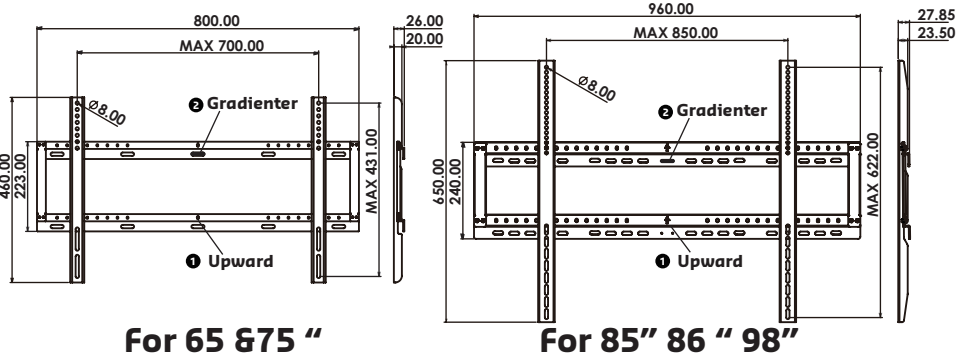

- As shown in the figure, an arrow is marked at position ①. The installation direction should be in accordance with the arrow upward.
- A gradienter meter is at position ②. You can adjust the horizontal direction according to the gradienter meter.

Package contents

Open the packages and check the contents. If any item is missing or damaged, please contact your dealer immediately.

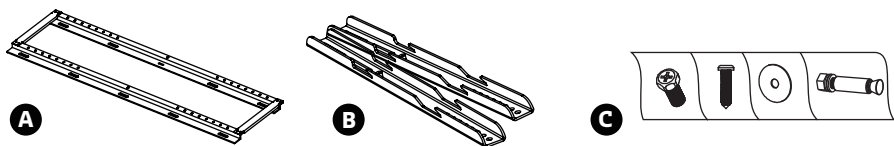

- | | |
|---------------------------------------|----------------|
| A. Monitor Wall Mount Bracket | x 1 pcs |
| B. Wall Mount Crossbar Bracket | x 2 pcs |
| C. Screws package | x 1 bag |
| D. Installation guide | x 1 pcs |

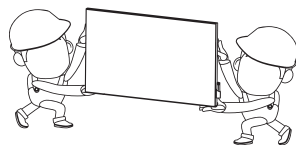

Safety precautions

- Please read this instruction before mounting and follow this step below precisely.
- It should be installed by at least two persons. Refer the installation to qualified technicians. Improper installation may cause the monitor to fall or malfunction.
- The installation site must be made of strong and solid material, such as solid brick or concrete, when in doubt, please consult contact technician, before installing.

Step. 1

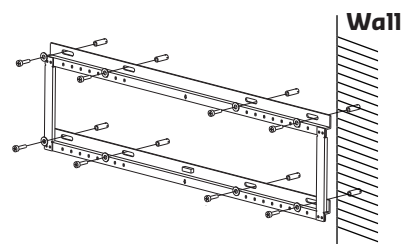

△ The diameter of the hole on the wall should be smaller than the diameter of the screws. (Note: the diameter of the hole on the wall should be smaller than 10mm.)

- As illustrated in left below positioning 8 holes on the wall and drill the holes at the corresponding position.
- Screw the "monitor wall mount bracket" with 8 expansion bolts to fix it on the wall. (4 on top line, 4 on the bottom line.)

Step. 3

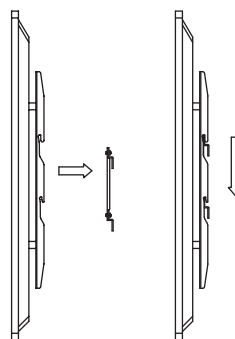

According to the step ①, ②, lock the wall "wall mount crossbar bracket" with the monitor onto the wall mount holder which has been fixed on the wall.

Step. 2

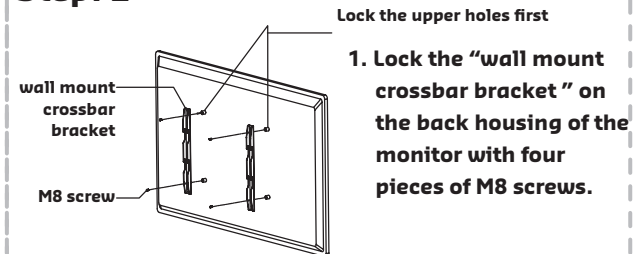

※ Caution: the direction of the connectors should be strictly confirm to the diagram illustrated above.)

- Attention! When locking the "wall mount crossbar bracket" on the monitor, please make sure the holes are in the same horizontal position.

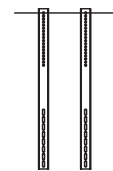

① Lock the holes in the same horizontal position.

Step. 4

Can be adjusted from left and right

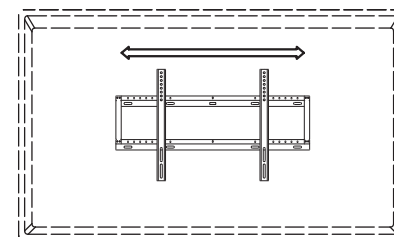

Check whether the wall mount connector is soundly locked onto the "monitor wall mount bracket". The monitor can be adjusted from left to right and vice versa.

壁掛安裝說明 65" & 75" , 85" & 86" & 98"

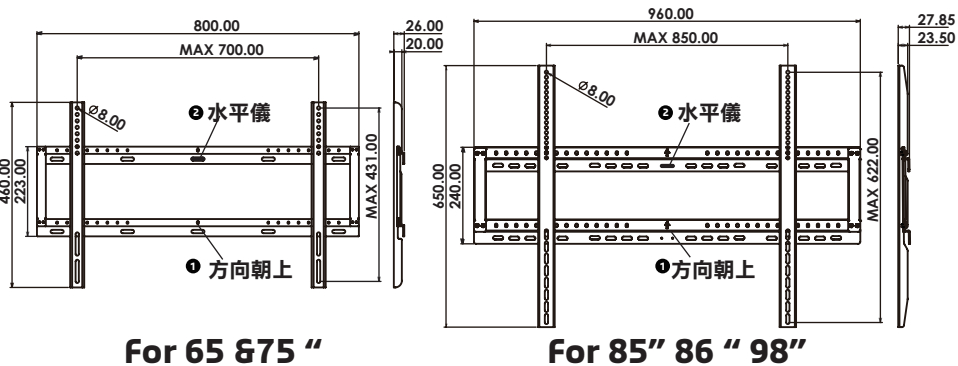

For 65 & 75"

For 85" 86" 98"

1. 如圖所示，位置 ❶ 處，安裝方向為箭頭朝上。
2. 位置 ❷ 處為水平儀，可根據水平調整水平方向。

❶ 壁掛架配件

開箱時，請檢查配件包內配件是否齊全。

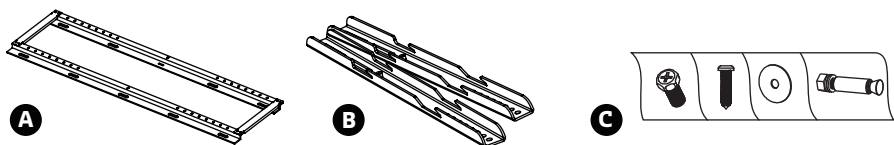

- A. 螢幕壁掛架 x 1 支
- B. 螢幕壁橫桿 x 2 支
- C. 螺絲配件包 x 1 袋
- D. 安裝說明書 x 1 份

❶ 安裝警告及注意事項

1. 在安裝前，請詳細閱讀本說明書，嚴格按照操作程序安裝。
2. 安裝時至少需要兩位成人負責安裝。請由合格技師負責進行安裝。安裝不當可能會造成產品故障或掉落或造成人員危險及傷害。
3. 安裝牆面必須由堅固結實的材料製成，如實心磚或混凝土...等，如有安裝上的疑問，請在安裝前諮詢技術人員。

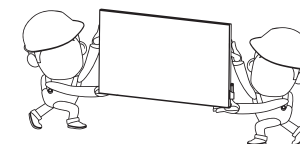

步驟1.

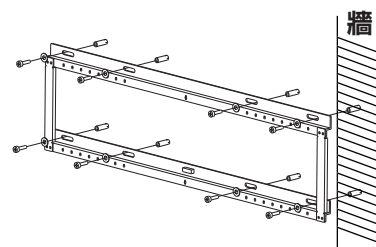

△ 請注意，在牆體上鑽孔直徑須小於螺絲釘直徑。
(注：孔的直徑需小於10mm)

1. 根據左方圖例所示，依據壁掛架上的合適孔位，在牆上鑽8個孔與壁掛架相對應。
2. 使用膨脹螺絲與壁虎(共8個)，再將壁掛固定在牆上。(上：4，下：4)

步驟3.

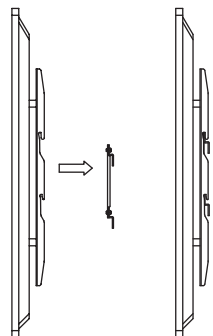

按照圖示步驟 ❶、❷ 將顯示器掛入壁掛架。

步驟2.

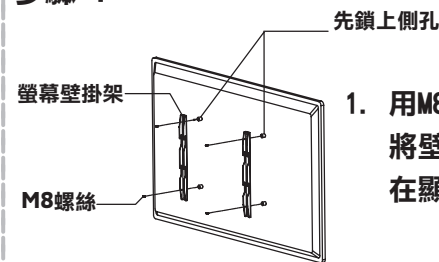

1. 用M8螺絲(4個)將壁掛架橫桿緊固在顯示器後殼上。

❶ 鎖在同一水平位置

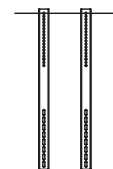

步驟4.

可左右滑動調整方向

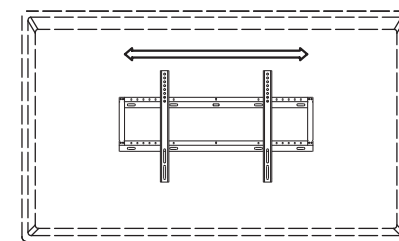

檢查壁掛架是否有安全裝入壁掛架，可左右滑動調整。

注意：一旦調整完畢，切勿再任意移動，避免傷害發生。